

EXCELL®

Pressure Washer Laveuse à pression Lavadora a presión

Record All Information and attach sales receipt here for future reference:

Purchase Date: _____

Serial #: _____

Operation Manual Guide d'utilisation Manual de operación XC2600

Questions? 1-800-888-2468

Learn more about your pressure washer, get answers to frequently asked questions, and register on line at www.excellpressurewasher.com



Table of Contents

Safety Guidelines/Definitions.....	2	Storage	16
Consumer Safety Information	2	Accessories	17
Important Safety Instructions	2-7	Repairs.....	17
Specifications	7	Trouble Shooting Guide.....	18-19
Carton Contents.....	8	Warranty.....	20
Assembly Instructions.....	8-9	Français	21-39
Operating Instructions	10-14	Español.....	40-60
Maintenance.....	15		

IMPORTANT

Please make certain that the person who is to use this equipment carefully reads and understands these instructions before operating.

IMPORTANT

Assurez-vous que toute personne qui utilisera cet équipement lise attentivement ces instructions avant de l'utiliser.

IMPORTANTE

Asegúrese de que la persona que va a usar esta herramienta lea cuidadosamente y comprenda estas instrucciones antes de utilizarla.

Part No.

SAFETY GUIDELINES - DEFINITIONS

This manual contains information that is important for you to know and understand. This information relates to protecting **YOUR SAFETY** and **PREVENTING EQUIPMENT PROBLEMS**. To help you recognize this information, we use the symbols below. Please read the manual and pay attention to these symbols.

<p>⚠ DANGER Indicates an imminently hazardous situation which, if not avoided, <u>will</u> result in <u>death or serious injury</u>.</p>	<p>⚠ CAUTION Indicates a potentially hazardous situation which, if not avoided, <u>may</u> result in <u>minor or moderate injury</u>.</p>
<p>⚠ WARNING Indicates a potentially hazardous situation which, if not avoided, <u>could</u> result in <u>death or serious injury</u>.</p>	<p>CAUTION Used without the safety alert symbol indicates a potentially hazardous situation which, if not avoided, <u>may</u> result in <u>property damage</u>.</p>

CONSUMER SAFETY INFORMATION



⚠ WARNING This product may not be equipped with a spark arresting muffler. If the product is not equipped and will be used around flammable materials, or on land covered with materials such as agricultural crops, forest, brush, grass, or other similar items, then an approved spark arrester must be installed and is legally required in the state of California. It is a violation of California statutes section 130050 and/or sections 4442 and 4443 of the California Public Resources Code, unless the engine is equipped with a spark arrester, as defined in section 4442, and maintained in effective working order. Spark arresters are also required on some U.S. Forest Service land and may also be legally required under other statutes and ordinances.

⚠ WARNING This product contains chemicals, including lead, known to the State of California to cause cancer, and birth defects or other reproductive harm. Wash hands after handling.

IMPORTANT SAFETY INSTRUCTIONS

⚠ WARNING Do not operate this unit until you have read and understand this Operators Manual and the Engine Owners Manual for Safety, Operation, and Maintenance Instructions.

READ AND SAVE THESE INSTRUCTIONS

<div style="display: flex; align-items: center;">   <div> <p>⚠ DANGER RISK OF EXPLOSION OR FIRE</p> </div> </div>	
WHAT CAN HAPPEN	HOW TO PREVENT IT
<ul style="list-style-type: none"> Spilled gasoline and it's vapors can become ignited from cigarette sparks, electrical arcing, exhaust gases and hot engine components such as the muffler. 	<ul style="list-style-type: none"> Shut off engine and allow it to cool before adding fuel to the tank. Use care in filling tank to avoid spilling fuel. Move pressure washer away from fueling area before starting engine.
<ul style="list-style-type: none"> Heat will expand fuel in the tank which could result in spillage and possible fire explosion. 	<ul style="list-style-type: none"> Fill tank to 1/2" (12.7 mm) below bottom of filler neck to provide space for fuel expansion.

RISK OF EXPLOSION OR FIRE (CONTINUED)

WHAT CAN HAPPEN	HOW TO PREVENT IT
<ul style="list-style-type: none"> Operating the pressure washer in an explosive environment could result in a fire. 	<ul style="list-style-type: none"> Operate and fuel equipment in well-ventilated areas free from obstructions. Equip areas with fire extinguisher suitable for gasoline fires.
<ul style="list-style-type: none"> Materials placed against or near the pressure washer can interfere with its proper ventilation features causing overheating and possible ignition of the materials. 	<ul style="list-style-type: none"> Never operate pressure washer in an area containing dry brush or weeds.
<ul style="list-style-type: none"> Muffler exhaust heat can damage painted surfaces, melt any material sensitive to heat (such as siding, plastic, rubber, vinyl or the pressure hose, itself), and damage live plants. 	<ul style="list-style-type: none"> Always keep pressure washer a minimum of 4' (1.2m) away from surfaces (such as houses, automobiles or live plants) that could be damaged from muffler exhaust heat.
<ul style="list-style-type: none"> Improperly stored fuel could lead to accidental ignition. Fuel improperly secured could get into the hands of children or other unqualified persons. 	<ul style="list-style-type: none"> Store fuel in an OSHA-approved container, in a secure location away from work area.
<ul style="list-style-type: none"> Use of acids, toxic or corrosive chemicals, poisons, insecticides, or any kind of flammable solvent with this product could result in serious injury or death. 	<ul style="list-style-type: none"> Do not spray flammable liquids

**▲ DANGER****RISK TO BREATHING (ASPHYXIATION)**

WHAT CAN HAPPEN	HOW TO PREVENT IT
<ul style="list-style-type: none"> Breathing exhaust fumes will cause serious injury or death! Engine exhaust contains carbon monoxide, an odorless and deadly gas. 	<ul style="list-style-type: none"> Operate pressure washer in a well-ventilated area. Avoid enclosed areas such as garages, basements, etc. Never operate unit in a location occupied by humans or animals.
<ul style="list-style-type: none"> Some cleaning fluids contain substances which could cause injury to skin, eyes or lungs. 	<ul style="list-style-type: none"> Use only cleaning fluids specifically recommended for high-pressure washers. Follow manufacturers recommendations. Do not use chlorine bleach or any other corrosive compound.



▲ DANGER RISK OF FLUID INJECTION AND LACERATION

WHAT CAN HAPPEN	HOW TO PREVENT IT
<ul style="list-style-type: none"> Your pressure washer operates at fluid pressures and velocities high enough to penetrate human and animal flesh, which could result in amputation or other serious injury. Leaks caused by loose fittings or worn or damaged hoses can result in injection injuries. DO NOT TREAT FLUID INJECTION AS A SIMPLE CUT! See a physician immediately! 	<ul style="list-style-type: none"> Inspect the high-pressure hose regularly. Replace the hose immediately if it is damaged, worn, has melted from contacting the engine, or shows any signs of cracks, bubbles, pinholes, or other leakage. Never grasp a high-pressure hose that is leaking or damaged. Never touch, grasp or attempt to cover a pinhole or similar water leak on the high-pressure hose. The stream of water IS under high pressure and WILL penetrate skin. Never place hands in front of nozzle. Direct spray away from self and others. Make sure hose and fittings are tightened and in good condition. Never hold onto the hose or fittings during operation. Do not allow hose to contact muffler. Never attach or remove wand or hose fittings while system is pressurized.
<ul style="list-style-type: none"> Injuries can result if system pressure is not reduced before attempting maintenance or disassembly. 	<ul style="list-style-type: none"> To relieve system pressure, shut off engine, turn off water supply and pull gun trigger until water stops flowing. Use only hoses and accessories rated for pressure higher than your pressure washer's PSI.



▲ DANGER RISK OF INJURY FROM SPRAY

WHAT CAN HAPPEN	HOW TO PREVENT IT
<ul style="list-style-type: none"> High-velocity fluid spray can cause objects to break, propelling particles at high speed. Light or unsecured objects can become hazardous projectiles. 	<ul style="list-style-type: none"> Always wear ANSI-approved Z87.1 safety glasses. Wear protective clothing to protect against accidental spraying. Never point wand at or spray people or animals. Always secure trigger lock when wand is not in service to prevent accidental operation. Never permanently secure trigger in pull-back (open) position.



▲ DANGER RISK OF UNSAFE OPERATION

WHAT CAN HAPPEN	HOW TO PREVENT IT
<ul style="list-style-type: none">• Unsafe operation of your pressure washer could lead to serious injury or death to you or others.	<ul style="list-style-type: none">• Do not use chlorine bleach or any other corrosive compound.• Become familiar with the operation and controls of the pressure washer.• Keep operating area clear of all persons, pets and obstacles.• Do not operate the product when fatigued or under the influence of alcohol or drugs. Stay alert at all times.• Never defeat the safety features of this product.• Do not operate machine with missing, broken or unauthorized parts.• Never leave wand unattended while unit is running.
<ul style="list-style-type: none">• If proper starting procedure is not followed, engine can kickback causing serious hand and arm injury.	<ul style="list-style-type: none">• If engine does not start after two pulls, squeeze trigger of gun to relieve pump pressure. Pull starter cord slowly until resistance is felt. Then pull cord rapidly to avoid kickback and prevent hand or arm injury.
<ul style="list-style-type: none">• The spray gun/wand is a powerful cleaning tool that could look like a toy to a child.	<ul style="list-style-type: none">• Keep children away from the pressure washer at all times.
<ul style="list-style-type: none">• Reactive force of spray will cause gun/wand to kickback, and could cause the operator to slip or fall or misdirect the spray. Improper control of gun/wand can result in injuries to self and others.	<ul style="list-style-type: none">• Do not overreach or stand on an unstable support.• Do not use pressure washer while standing on a ladder.• Grip gun/wand firmly with both hands. Expect the gun to kickback when triggered.



⚠ DANGER

RISK OF INJURY OR PROPERTY DAMAGE WHEN TRANSPORTING OR STORING

WHAT CAN HAPPEN

- Fuel or oil can leak or spill and could result in fire or breathing hazard. Serious injury or death can result. Fuel or oil leaks will damage carpet, paint or other surfaces in vehicles or trailers.

HOW TO PREVENT IT

- If pressure washer is equipped with a fuel shut-off valve, turn the valve to the OFF position before transporting to avoid fuel leaks. If pressure washer is not equipped with a fuel shut-off valve, drain the fuel from tank before transporting. Only transport fuel in an OSHA-approved container. Always place pressure washer on a protective mat when transporting to protect against damage to vehicle from leaks. Remove pressure washer from vehicle immediately upon arrival at your destination.



⚠ WARNING

RISK OF BURSTING

WHAT CAN HAPPEN

- Over inflation of tires could result in serious injury and property damage.

HOW TO PREVENT IT

- Use a tire pressure gauge to check the tires pressure before each use and while inflating tires; see the tire sidewall for the correct tire pressure.
NOTE: Air tanks, compressors and similar equipment used to inflate tires can fill small tires similar to these very rapidly. Adjust pressure regulator on air supply to no more than the rating of the tire pressure. Add air in small increments and frequently use the tire gauge to prevent over inflation.

- High-velocity fluid spray directed at pneumatic tire sidewalls (such as found on automobiles, trailers and the like) could damage the sidewall resulting in serious injury.

- On pressure washers rated above 1600 PSI (110 Bar) use the widest fan spray (40° nozzle) and keep the spray a minimum of 8" (20 cm) from the pneumatic tire sidewall. Do not aim spray directly at the joint between the tire and rim.



⚠ WARNING

RISK OF HOT SURFACES

WHAT CAN HAPPEN

- Contact with hot surfaces, such as engines exhaust components, could result in serious burn.

HOW TO PREVENT IT

- During operation, touch only the control surfaces of the pressure washer. Keep children away from the pressure washer at all times. They may not be able to recognize the hazards of this product.

**▲WARNING RISK OF CHEMICAL BURN**

WHAT CAN HAPPEN	HOW TO PREVENT IT
<ul style="list-style-type: none"> Use of acids, toxic or corrosive chemicals, poisons, insecticides, or any kind of flammable solvent with this product could result in serious injury or death. 	<ul style="list-style-type: none"> Do not use acids, gasoline, kerosene, or any other flammable materials in this product. Use only household detergents, cleaners and degreasers recommended for use in pressure washers. Wear protective clothing to protect eyes and skin from contact with sprayed materials.

**▲WARNING RISK OF ELECTRICAL SHOCK**

WHAT CAN HAPPEN	HOW TO PREVENT IT
<ul style="list-style-type: none"> Spray directed at electrical outlets or switches, or objects connected to an electrical circuit, could result in a fatal electrical shock. 	<ul style="list-style-type: none"> Unplug any electrically operated product before attempting to clean it. Direct spray away from electric outlets and switches.

**▲WARNING RISK OF INJURY FROM LIFTING**

WHAT CAN HAPPEN	HOW TO PREVENT IT
<ul style="list-style-type: none"> Serious injury can result from attempting to lift too heavy an object. 	<ul style="list-style-type: none"> The pressure washer is too heavy to be lifted by one person. Obtain assistance from others before lifting.

READ AND SAVE THESE INSTRUCTIONS**SPECIFICATIONS**

Model	XC2600
PSI Max*	2600
Operating PSI	2340
GPM Max*	2.5
Operating GPM	2.25

* Water flow and maximum pressure ratings determined in accordance with PWMA standard PW101.

NOTE: Photographs and line drawings used in this manual are for reference only and do not represent a specific model.

CARTON CONTENTS

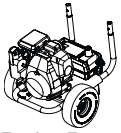

Engine Frame and Wheel Assembly

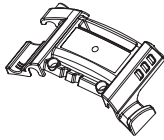

Accessories Panel

Operation Manual

Engine Manual



Chemical Hose



Cleaning Tool



Screws



High Pressure Hose

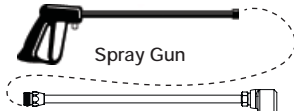

Spray Gun

Gatling Spray Wand

Bagged Parts

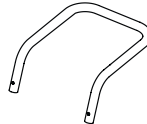

Handle

ASSEMBLY INSTRUCTIONS

1. Locate and remove all loose parts from the carton.
2. Cut four corners of the carton from top to bottom and lay the panels flat.

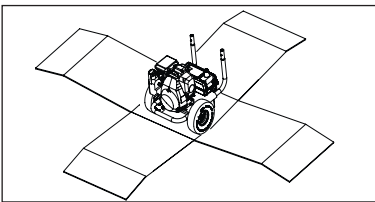
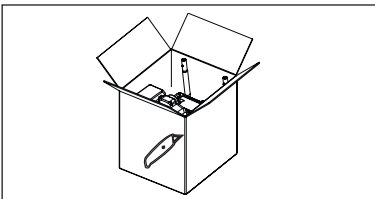

3. Place handle onto frame, depress the snap buttons, and slide the handle assembly onto the frame until snap buttons snap into place.

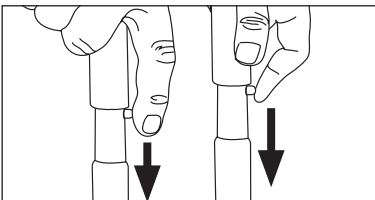

CAUTION Risk of personal injury. Avoid placing hands between handle and frame when assembling to prevent pinching.

4. To Assemble Accessories Panel
 - a. Align the screw boss on the accessories panel assembly with the hole in the handle and slide accessories panel assembly onto handle.

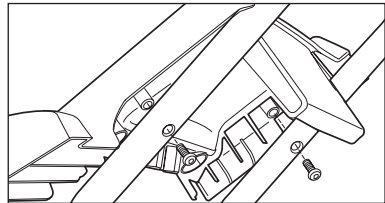

- b. Secure accessories panel assembly to handle with screws. Do not overtighten.

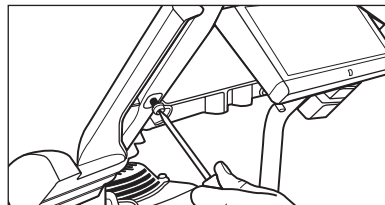

5. **Connect wand to gun.** Tighten securely.

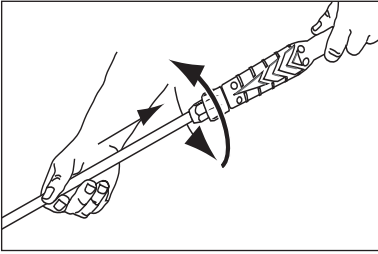

6. **Attach high pressure hose to gun.** Tighten securely.

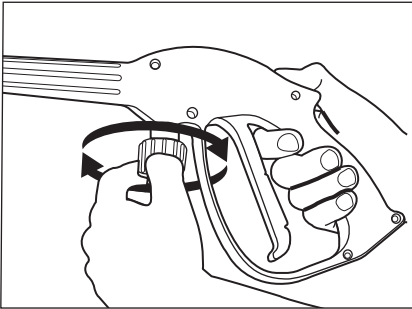

7. **Roll the unit off the carton** and discard carton.

NOTE: The pump on this unit is maintenance free and requires no oil. If there is a problem with the pump contact an Authorized Service Center.

▲ WARNING: **Risk of bursting.** Use a tire pressure gauge to check the tires pressure before each use and while inflating tires; see the tire sidewall for the correct tire pressure.

NOTE: Air tanks, compressors and similar equipment used to inflate tires can fill small tires similar to these very rapidly. Adjust pressure regulator on air supply to no more than the rating of the tire pressure. Add air in small increments and frequently use the tire gauge to prevent over inflation.

OPERATING INSTRUCTIONS

Compare the illustrations with your unit to familiarize yourself with the location of various controls and adjustments. Save this manual for future reference.

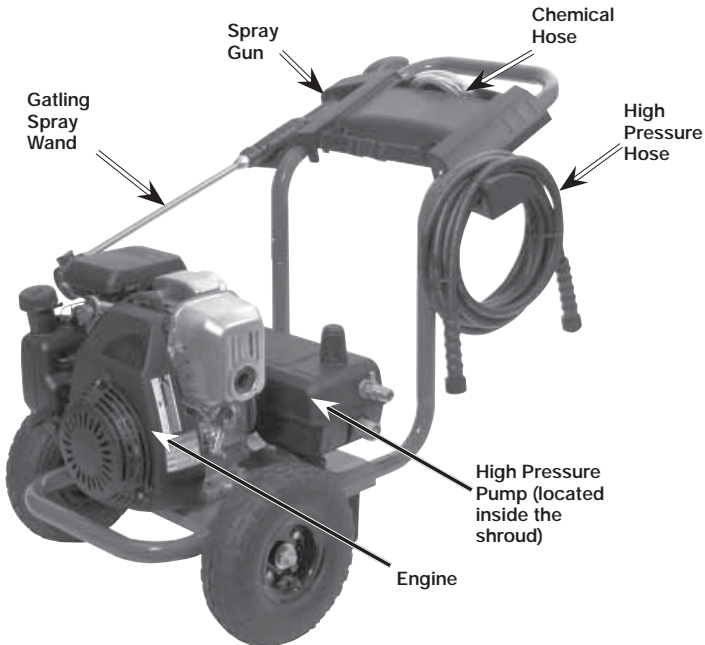

BASIC ELEMENTS OF A PRESSURE WASHER

High Pressure Pump (located inside the shroud): Increases the pressure of the water supply.

Engine: Drives the high pressure pump.

High Pressure Hose: Carries the pressurized water from the pump to the gun and spray wand.

Spray Gun: Connects with spray wand to control water flow rate, direction, and pressure.

Gatling Spray Wand: Allows the user to quickly change high-pressure nozzles. See How To Use Spray Wand instructions in this section.

Chemical Hose: Feeds cleaning agents to the pump to mix with the water. See How To Apply Chemicals/ Cleaning Solvents instructions in this section.

BASIC ELEMENTS OF AN ENGINE

Refer to the engine manual for location and operation of engine controls.

Choke Control: Opens and closes carburetor choke valve.

Starter Grip: Pulling starter grip operates recoil starter to crank engine.

Engine Switch: Enables and disables ignition system.

PRESSURE WASHER TERMINOLOGY

PSI: Pounds per Square Inch. The unit of measure for water pressure. Also used for air pressure, hydraulic pressure, etc.

GPM: Gallons Per Minute. The unit of measure for the flow rate of water.

CU: Cleaning Units. GPM multiplied by PSI. $GPM \times PSI = CU$

Bypass Mode: Allows water to re-circulate within pump when the gun trigger is not pulled.

⚠ CAUTION: Allowing the unit to run for more than two minutes without the gun trigger pulled could cause overheating and damage to the pump.

Chemical Injection System: Mixes cleaners or cleaning solvents with the water to improve cleaning effectiveness.

Water Supply: All pressure washers must have a source of water. The minimum requirements for a water supply are 20 PSI and 5 gallons per minute.

PRESSURE WASHER OPERATING FEATURES

PRESSURE ADJUSTMENTS

The pressure setting is preset at the factory to achieve optimum pressure and cleaning. If you need to lower the pressure, it can be accomplished by these methods.

1. **Back away from the surface to be cleaned.** The further away you are, the less the pressure will be on the surface to be cleaned.
2. **Change to the 40° nozzle** - this nozzle delivers a less powerful stream of water and a wider spray pattern.

⚠ CAUTION: DO NOT attempt to increase pump pressure. A higher pressure setting than the factory set pressure may damage pump.

⚠ WARNING To reduce the risk of injury, read the pressure washer instruction manual and the engine instruction manual before starting pressure washer.

⚠ DANGER Risk of fluid injection and laceration. When using the high-pressure setting, DO NOT allow the high-pressure spray to come in contact with unprotected skin, eyes, or with any pets or animals. Serious injury will occur.

- Your washer operates at fluid pressures and velocities high enough to penetrate human and animal flesh, which could result in amputation or other serious injury. Leaks caused by loose fittings or worn or damaged hoses can result in injection injuries. DO NOT TREAT FLUID INJECTION AS A SIMPLE CUT! See a physician immediately!

⚠ WARNING Risk of Fire, Asphyxiation and Burn. NEVER fill fuel tank when engine is running or hot. Do not smoke when filling fuel tank.

- NEVER fill fuel tank completely. Fill tank to 1/2" (12.7 mm) below bottom of filler neck to provide space for fuel expansion. Wipe any fuel spillage from engine and equipment before starting engine.
- NEVER run engine indoors or in enclosed, poorly ventilated areas. Engine exhaust contains carbon monoxide, an odorless and deadly gas.
- DO NOT let hoses come in contact with very hot engine muffler during or immediately after use of your pressure washer. Damage to hoses from contact with hot engine surfaces will NOT be covered by warranty.

CAUTION Risk of property damage. NEVER pull water supply hose to move pressure washer. This could damage hose and/or pump inlet.

- DO NOT use hot water, use cold water only.
- NEVER turn water supply off while pressure washer engine is running or damage to pump will result.
- DO NOT stop spraying water for more than two minutes at a time. Pump operates in bypass mode when spray gun trigger is not pressed. If pump is left in bypass mode for more than two minutes internal components of the pump can be damaged.

If you do not understand these precautions, please call 1-800-888-2468 to speak to a service representative for further instructions.

TO USE GATLING™ SPRAY WAND

The nozzles for the spray wand are stored in the gatling spray wand. See chart to choose the correct nozzle for the job to be performed.

CHANGING NOZZLES ON SPRAY WAND

⚠ DANGER Risk of fluid injection. Do not direct discharge stream toward persons, unprotected skin, eyes or any pets or animals. Serious injury will occur.

⚠ WARNING Risk of fluid injection. Do Not attempt to change nozzles while pressure washer is running. Turn engine off before changing nozzles.

1. Press turret release button to release turret.
2. Rotate turret to chosen nozzle.
3. Push turret onto nozzle and lock into place.

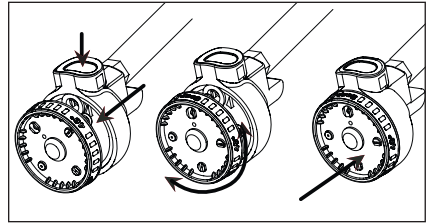

	0°	15°	40°	Soap
Spray Pattern				
Uses	powerful pinpoint for very intense cleaning	intense cleaning of small areas	intense cleaning of larger areas	applies cleaning solutions
Surfaces *	Metal or concrete DO NOT use on wood	metal, concrete, or wood	metal, concrete, or wood	metal, concrete, wood, or vinyl

* **CAUTION** The high pressure spray from your pressure washer is capable of causing damage to surfaces such as wood, glass, automobile paint, auto striping and trim, and delicate objects such as flowers and shrubs. Before spraying, check the item to be cleaned to assure yourself that it is strong enough to resist damage from the force of the spray.

HOW TO APPLY CHEMICALS AND CLEANING SOLVENTS

Applying chemicals or cleaning solvents is a low pressure operation.

NOTE: Use only soaps and chemicals designed for pressure washer use. **Do not use bleach.**

To Apply chemicals:

1. **Make sure the chemical hose is pressed** onto the barbed fitting located near high pressure hose connection of pump as shown.
2. **Place other end of chemical hose** with filter on it into container holding chemical/cleaning solution. **NOTE:** For every 7 gallons of water pumped 1 gallon of chemical/cleaning solution will be used.
3. **Select the soap nozzle** on the Gatling spray wand, see To Use Gatling Spray Wand paragraph in this section.
4. **After use of chemicals**, place chemical hose into container of clean water and draw clean water through chemical injection system to rinse system thoroughly. If chemicals remain in the pump it could be damaged. Pumps damaged due to chemicals will not be covered under warranty.

NOTE: Chemicals and soaps will not siphon when spray wand is in the high pressure setting.

STARTING

Prior to starting, refer to your engine manual for proper starting procedure.

1. **In a well ventilated outdoor area** add fresh, high quality, unleaded gasoline with a pump octane rating of 86 or higher. Do not overfill. Wipe up spilled fuel before starting the engine. Refer to Engine Owners Manual for correct procedure.

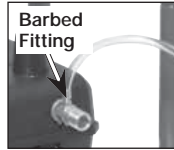

2. **Check engine oil level.** See Engine Owners Manual for correct procedure.
3. **Connect the water hose to the water source.** Turn the water source on to remove all air from the hose. When a steady stream of water is present, turn the water source off.
4. **Verify the filter screen** is in water inlet of pump. **NOTE:** Cone side faces out.
5. **Connect water source to pump inlet.** **NOTE:** Water source must provide a minimum of 5 gallons per minute at 20 PSI.

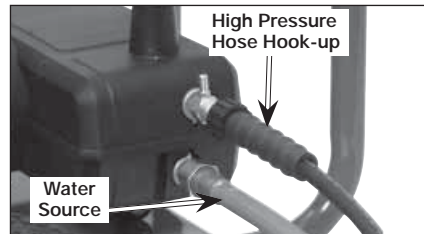
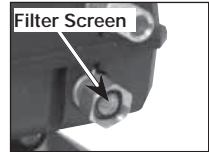

⚠ WARNING To reduce the possibility of contamination always protect against backflow when connected to a potable water system.

6. **Connect high pressure hose** to pump outlet.
 7. **If applying a chemical or cleaning solution**, see How To Apply Chemicals/Cleaning Solvents instructions in this section.
 8. **Turn water source on.**
- CAUTION** Risk of property damage. Failure to do so could cause damage to the pump.
9. **Remove all air from the pump and high pressure hose** by depressing trigger until a steady stream of water is present.
 10. **Start engine.** See Engine Owners Manual for correct procedure.

⚠ WARNING Risk of unsafe operation. If engine does not start after two pulls, squeeze trigger of gun to relieve pump pressure. Pull starter cord slowly until resistance is felt. Then pull cord rapidly to avoid kickback and prevent hand or arm injury.

11. Depress trigger on gun to start water flow.

⚠ WARNING Risk of unsafe operation. Stand on a stable surface and grip gun/spray wand firmly with both hands. Expect the gun to kick when triggered.

12. Release trigger to stop water flow.

⚠ DANGER Risk of injury from spray. Always engage the trigger lock when gun is not in use. Failure to do so could cause accidental spraying.



13. Adjust nozzle spray for the task being performed. See How To Use Wand instructions in this section.

SHUTTING DOWN

1. After each use, if you have applied chemicals, place chemical hose into container of clean water and draw clean water through chemical injection system to rinse system thoroughly.

CAUTION Risk of property damage. Failure to do so could cause damage to the pump.

2. Turn engine off. See Engine Owner's Manual.

CAUTION Risk of property damage. NEVER turn the water off with the engine running.

3. Turn water source off.

4. Pull trigger on spray gun to relieve any water pressure in hose or spray gun.

5. See Storage section in this manual for proper storage procedures.

MAINTENANCE

⚠ WARNING Risk of burn hazard. When

performing maintenance, you may be exposed to hot surfaces, water pressure or moving parts that can cause serious injury or death.

⚠ WARNING Risk of fire hazard. Always disconnect, spark plug wire, let the engine cool and release all water pressure before performing any maintenance or repair. The engine contains flammable fuel. Do not smoke or work near open flames while performing maintenance.

To ensure efficient operation and longer life of your pressure washer, a routine maintenance schedule should be prepared and followed. If the pressure washer is used in unusual conditions, such as high-temperatures or dusty conditions, more frequent maintenance checks will be required.

ENGINE

Consult the Engine Owners Manual for the manufacturer's recommendations for any and all maintenance. **NOTE:** The frame is equipped with an oil drain hole to help make changing the engine oil easier.

PUMP

The pump on this unit is maintenance free and requires no oil, if there is a problem with the pump contact an Authorized Service Center.

NOZZLE CLEANING

If the nozzle becomes clogged with foreign materials, such as dirt, excessive pressure may develop. If the nozzle becomes partially clogged or restricted, the pump pressure will pulsate. Clean the nozzle immediately using the nozzle kit supplied and the following instructions:

1. Shut off the pressure washer and turn off the water supply.
2. Pull trigger on gun handle to relieve any water pressure.

3. Disconnect the spray wand from the gun.
4. Release the Gatling turret. Remove any obstructions with the nozzle cleaning tool provided and backflush with clean water.

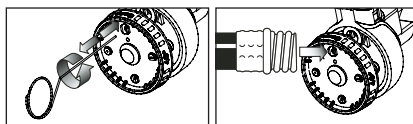

5. Direct water supply into nozzle to backflush loosened particles for 30 seconds.
6. Choose nozzle and lock turret into place.
7. Reconnect spray wand to gun and turn on water supply.
8. Start pressure washer and place spray wand into high pressure setting to test.

HOW TO CLEAN THE WATER INLET FILTER

This screen filter should be checked periodically and cleaned if necessary.

1. **Remove filter** by grasping end and removing it from water inlet of pump as shown.

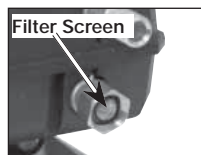

2. **Clean filter** by flushing it with water on both sides.
3. **Re-insert filter** into water inlet of pump. **NOTE:** Cone side faces out.

NOTE: Do not operate pressure washer without filter properly installed.

STORAGE

ENGINE

Consult the Engine Owners Manual for the manufacturer's recommendations for storage.

PUMP

The manufacturer recommends using a pump protector/winterizer, such as DP80 when storing the unit for more than 30 days and/or when freezing temperatures are expected. DP80 is available at the store where the pressure washer was purchased. If a pump protector/winterizer is not available, RV antifreeze needs to be run through the pump as outlined in the steps below.

NOTE: Using a pump protector/winterizer or RV antifreeze is to provide proper lubrication to the internal seals of the pump regardless of temperature or environment.

1. Obtain a funnel, 6 oz. (170 mL) of RV antifreeze and 16–36" (40–91cm) of garden hose with a male hose connector attached to one end.

CAUTION

Risk of property damage. Use only RV antifreeze. Any other antifreeze is corrosive and can damage pump.

2. Disconnect spark plug wire.
3. Connect length of garden hose to water inlet of pump.



4. Add RV antifreeze to hose as shown.
5. Pull engine starter rope slowly several times until antifreeze comes out of high-pressure hose connection of pump.
6. Remove garden hose from water inlet of pump.
7. Reconnect spark plug wire.

PRESSURE WASHER

1. Drain all water from high pressure hose, coil it and store it in cradle of the pressure washer handle.
2. Drain all water from spray gun and wand by holding spray gun in a vertical position with nozzle end pointing down and squeezing trigger. Store in gun holder.
3. Store chemical hose so it is protected from damage.
4. If space is needed, remove handles and replace as shown.



ACCESSORIES PANEL

The accessories panel was designed to hold several accessories that can be purchased separately at the store where this pressure washer was purchased.



ACCESSORIES

Recommended accessories for use with your pressure washer are available for purchase from your local retailer or authorized service center. If you need assistance in locating any accessory for your tool, please call 1-800-888-2468 or visit our website www.excellpressurewasher.com.

▲ DANGER Risk of fluid injection. When using replacement lances or guns with this pressure washer, **DO NOT** use a lance and/or lance/gun combination that is shorter in length than what was provided with this pressure washer as measured from the nozzle end of the lance to the gun trigger.

▲ CAUTION The use of any other accessory not recommended for use with this tool could be hazardous. Use only EXCELL branded accessories rated equal to or greater than the rating of the pressure washer.

REPAIRS

To assure product SAFETY and RELIABILITY, repairs, maintenance and adjustment should be performed by an Authorized Warranty Service Center. Always use identical replacement parts. For the location of the nearest Authorized Warranty Service Center call 1-800-888-2468 or visit our website www.excellpressurewasher.com.

TROUBLE SHOOTING GUIDE

PROBLEM	CAUSE	CORRECTION
Engine will not start (see Engine Manual for further engine troubleshooting)	No fuel.	Add Fuel.
	Pressure builds up after two pulls on the recoil starter or after initial use.	Squeeze gun trigger to relieve pressure.
	Choke lever in the "No Choke" position.	Move choke to the "Choke" position.
	Spark plug wire not attached.	Attach spark plug wire.
	Engine switch in OFF position.	Place engine switch in ON position.
	Choke lever in the "Choke" position on a "hot" engine or an engine that has been exposed to thermal heat for a long period of time.	Move choke to the "No Choke" position.
No or low pressure (initial use)	Spray wand not in high pressure.	See How to Use Spray Wand instructions in the Operation Section.
	Low water supply.	Water supply must be at least 5 GPM @ 20 PSI.
	Leak at high pressure hose fitting.	Repair leak. Apply sealant tape if necessary.
	Nozzle obstructed.	See Nozzle Cleaning instructions in the Maintenance section.
	Water filter screen clogged.	Remove and clean filter.
	Air in hose.	Turn off the engine, then the water source. Disconnect the water source from the pump inlet and turn the water source on to remove all air from the hose. When there is a steady stream of water present, turn water source off. Re-connect water source to pump inlet and turn on water source. Squeeze trigger to remove remaining air
	Choke in the "Choke" position.	Move choke to the "No Choke" position.
High pressure hose is too long.	Use high pressure hose under 100 feet.	

PROBLEM	CAUSE	CORRECTION
Will not draw chemicals	Spray wand not in low pressure.	See How to Use Spray Wand paragraph in the Operation Section.
	Chemical filter clogged.	Clean filter.
	Chemical screen not in cleaning solution.	Make sure end of chemical hose is fully submerged into cleaning solution.
	Chemical too thick.	Dilute chemical. Chemical should be the same consistency as water.
	Pressure hose is too long	Lengthen water supply hose instead of high pressure hose.
	Chemical build up in chemical injector.	Have parts cleaned or replaced by AWSC.
No or low pressure (after period of normal use)	Worn seal or packing	Have replaced by AWSC.
	Worn or obstructed valves.	Have replaced by AWSC.
	Worn unloader piston.	Have replaced by AWSC.
Water leaking at gun/spray wand connection	Worn or broken o-ring.	Check and replace.
	Loose hose connection.	Tighten.
Water leaking at pump	Loose connections.	Tighten.
	Piston packings worn.	Have replaced by AWSC.
	Worn or broken o-rings.	Have replaced by AWSC.
	Pump head or tubes damaged from freezing.	Have replaced by AWSC.
Pump Pulsates	Nozzle obstructed.	See Nozzle Cleaning paragraph in the Maintenance section for the correct procedure.

AWSC = Authorized Warranty Service Center

LIMITED WARRANTY

ONE YEAR LIMITED WARRANTY ON PRODUCT COMPONENTS EXCLUDING PUMP

Black & Decker (U.S.) Inc. warrants to the original purchaser that the frame, wheels, gun, hose, wand, spray nozzle(s) and other components of the Excell pressure washers covered under this warranty are free from defects in material and workmanship for one year from the date of purchase.

TWO YEAR LIMITED WARRANTY ON PUMP

Black & Decker warrants to the original purchaser that the pump of the Excell pressure washers covered under this warranty is free from defects in material and workmanship for two years from the date of purchase. The two year limited warranty applies to the pump only.

Black & Decker will repair or replace, at Black & Decker's option, products or components which have failed within the above warranty periods. Service will be scheduled according to the normal work flow and business hours at the service center location, and the availability of replacement parts. All decisions of Black & Decker with regard to this limited warranty shall be final.

This warranty gives you specific legal rights, and you may also have other rights which vary from state to state.

RESPONSIBILITY OF ORIGINAL PURCHASER (Initial User):

- To process a warranty claim on your Excell pressure washer, return it to the place of purchase.
- Retain original cash register sales receipt as proof of purchase for warranty work.
- Use reasonable care in the operation and maintenance of the product as described in the Owners Manual(s).

THIS WARRANTY DOES NOT COVER:

- Merchandise sold as reconditioned, used as rental equipment, or floor or display models.
- Merchandise that has become damaged or inoperative because of ordinary wear, misuse, cold, heat, rain, excessive humidity, freeze damage, use of improper chemicals, negligence, accident, failure to operate the product in accordance with the instructions provided in the Owners Manual(s) supplied with the product, improper maintenance, the use of accessories or attachments not recommended by Black & Decker, or unauthorized repair or alterations.
- Repair and transportation costs of merchandise determined not to be defective.
- Costs associated with assembly, required oil, adjustments or other installation and start-up costs.
- Expendable parts or accessories supplied with the product which are expected to become inoperative or unusable after a reasonable period of use, including but not limited to springs, nozzles, o-rings, washers, and similar accessories.
- Merchandise sold by Black & Decker which has been manufactured by and identified as the product of another company, such as gasoline engines. The product manufacturer's warranty, if any, will apply.
- **ANY INCIDENTAL, INDIRECT OR CONSEQUENTIAL LOSS, DAMAGE, OR EXPENSE THAT MAY RESULT FROM ANY DEFECT, FAILURE OR MALFUNCTION OF THE PRODUCT IS NOT COVERED BY THIS WARRANTY.** Some states do not allow the exclusion or limitation of incidental or consequential damages, so the above limitation or exclusion may not apply to you.
- **IMPLIED WARRANTIES, INCLUDING THOSE OF MERCHANTABILITY OR FITNESS FOR A PARTICULAR PURPOSE, ARE LIMITED TO ONE YEAR FROM THE DATE OF ORIGINAL PURCHASE.** Some states do not allow limitations on how long an implied warranty lasts, so the above limitations may not apply to you.